

# Komínové príslušenstvo „Modrá Séria“

Iba pre tradičné "TURBO" kotly

Farba povrchu RAL 9010

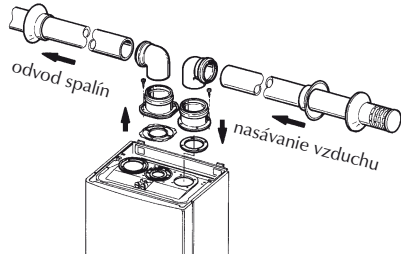

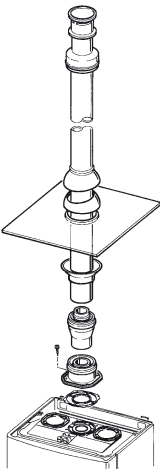
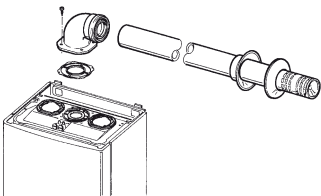
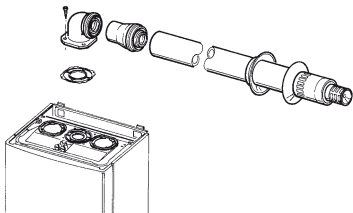



Komínové príslušenstvo pre tradičné "TURBO" kotly

KOMÍNOVÉ SADY NASÁVANIE/ODVOD „Modrá Séria“				
Popis	Obrázok	Kód	Cena bez DPH	Cena s DPH
Rozdeľovacia sada Ø 80/80		3.010351	76,- €	91,20 €
Koncentrická vertikálna sada Ø 80/125 - farba čierna		3.010352	162,- €	194,40 €
Koncentrická horizontálna sada Ø 60/100		3.014147	56,- €	67,20 €
		3.019768	45,- €	54,- €
Koncentrická horizontálna sada Ø 80/125		3.010526	137,- €	164,40 €

# Násuvné komínové komponenty (iba pre tradičné "TURBO" kotly)

# „Modrá Séria“

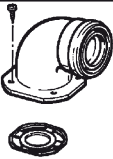
Farba povrchu RAL 9010







PREDLŽOVACIE POTRUBIA				
Popis	Obrázok	Kód	Cena bez DPH	Cena s DPH
Predĺženie 0,5 m Ø 80		3.011491	7,50 €	9,- €
Predĺženie 1 m Ø 80		3.010741	14,- €	16,80 €
Predĺženie 2 m Ø 80		3.011167	26,- €	31,20 €
KONCENTRICKÉ POTRUBIA				
Predĺženie 0,5 m Ø 60/100		3.018278	18,- €	21,60 €
Predĺženie 1 m Ø 60/100		3.018277	27,50 €	33,- €
Predĺženie 2 m Ø 60/100		3.010739	57,50 €	69,- €
Predĺženie 0,5 m Ø 80/125		3.011157	27,50 €	33,- €
Predĺženie 1 m Ø 80/125		3.010945	46,50 €	55,80 €
Predĺženie 2 m Ø 80/125		3.010946	95,50 €	114,60 €
KOLENÁ 90°				
Koleno 90° Ø 80		3.010955	10,50 €	12,60 €
Koleno 90° F/F Ø 80		3.011571	14,- €	16,80 €
KOLENÁ 45°				
Koleno 45° Ø 80		3.010956	12,50 €	15,- €
KONCENTRICKÉ KOLENÁ 90°				
Koleno 90° koncentrické Ø 60/100 s prírubou v cene je držiak + tesnenia		3.020015	47,- €	56,40 €
Koleno 90° Ø 60/100		3.010949	24,- €	28,80 €
Koleno 90° Ø 80/125		3.010951	39,- €	46,80 €

# Násuvné komínové komponenty (iba pre tradičné "TURBO" kotly)

Farba povrchu RAL 9010

# „Modrá Séria“

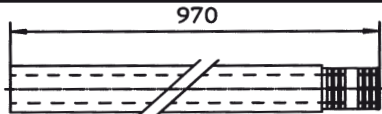
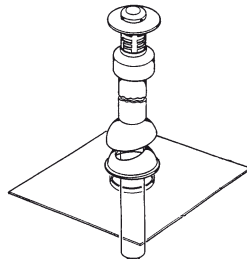
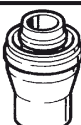
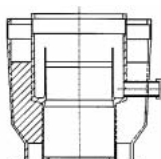



Komínové príslušenstvo pre tradičné "TURBO" kotly

KONCETRICKÉ KOLENÁ 45°				
Popis	Obrázok	Kód	Cena bez DPH	Cena s DPH
Koleno 45° Ø 60/100		3.010950	23,- €	27,60 €
Koleno 45° Ø 80/125		3.010952	35,50 €	42,60 €
PRIPOJOVACIE PRÍRUBY				
Pripojovacie príruby Ø 80/80		3.011570	25,50 €	30,60 €
Pripojovacia príruha koncentrická Ø 60/100		3.011141	18,50 €	22,20 €
KONCOVKY ODVODU SPALÍN				
Horizontálna koncovka odvodu spalín Ø 60/100		3.011572	34,- €	40,80 €
Koncentrická vertikálna koncovka Ø 60/100 - farba červenohnedá <i>Musí sa kombinovať s koncentrickou pripojovacou prírubou (Kód 3.011141)</i>		3.015631	108,- €	129,60 €
ADAPTÉR				
Redukcia Ø 60/100 - Ø 80/125		3.010957	29,- €	34,80 €
ZBERAČE KONDENZÁTU				
Zberač kondenzátu Ø 80/125		3.010960	38,- €	45,60 €
Zberač kondenzátu Ø 80		3.012009	18,- €	21,60 €

# Násuvné komínové komponenty (iba pre tradičné "TURBO" kotly)

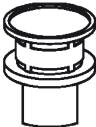
# „Modrá Séria“

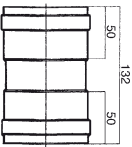
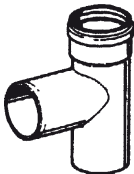
Farba povrchu RAL 9010

KONCOVKY				
Popis	Obrázok	Kód	Cena bez DPH	Cena s DPH
Koncová mriežka proti vetru Ø 80 materiál: antikor		3.010962	15,- €	18,- €
Vertikálna koncovka Ø 80 farba biela		3.011488	26,- €	31,20 €
SADY TESNENÍ KOMÍNA				
Tesnenie Ø 60		1.025894	0,75 €	0,90 €
Tesnenie Ø 80		3.011144	2,- €	2,40 €
Tesnenie Ø 100		3.011145	3,- €	3,60 €
Tesnenie Ø 125		3.011146	3,50 €	4,20 €
Tesnenie Ø 60/100		1.020374	6,- €	7,20 €
SPOJKA POTRUBIA				
Spojka F/F Ø 80		3.012714	13,- €	15,60 €
REVÍZNE KOMPONENTY				
Koleno 90° koncentrické Ø 60/100 s revíz. otvorom		3.016172	54,- €	64,80 €
Koleno 90° koncentrické Ø 80/125 s revíz. otvorom		3.016171	72,50 €	87,- €
Koleno 90° Ø 80 s revíznym otvorom		3.016175	39,- €	46,80 €
Pripojovací T-kus Ø 80 s revíznym otvorom		3.011595	23,- €	27,60 €
Kryt pod T-kus Ø 80 s odvodom kondenzátu		3.011961	23,50 €	28,20 €